



www.mifab.com

CPORT-2015

Go to www.mifab.com for the most current product specification sheets.



**C-PORT Rubber Supports List Price Guide
LIT-047**

TABLE OF CONTENTS

CXM & C5 (Small supports) 2
 CXP (Supports without strut) 2
 C (Standard supports with strut) 3
 C5 & C6 (Supports with 1 5/8" high strut) 3
 CXW (Widebody support without strut) 4
 CW (Widebody support with strut) 4
 CGW (Widebody support with strut and gasket) 5
 CE (Extension support, regular base) 6
 CEW (Extension support, widebody base) 6
 CRM (Roller series, mini support) 7
 CR (Roller series, regular support) 7
 CRE (Roller series, extended, regular support) 8
 CREW (Roller series, extended, widebody support) 8
 CB (Bridge support) 9
 CES (Bridge support, medium load) 9
 CESHW (Bridge support, widebody) 10
 CESW (Water and steam support, widebody, medium load) 11
 CESWX (Water and steam support, double widebody, heavy load) 12
 CESWXX (Water and steam support, quadruple widebody, extra heavy load) 12
 DSA10 (Duct support, regular base) 13
 DSAW (Duct support, widebody base) 13
 CS (Vari-angle support) 14
 CSE (Copper Tube and Steel Support) 15
 CZ (Seismic support) 14
 AP (HVAC support, strips) 15
 CC (Copper piping support) 16
 CP (Platform support) 16
 Load Bearing Chart 17
 Cross Reference 18-19
 Cush-A-Clamp and Pipe Strap Clamps 20
 Terms and Warranties 22

There are 280 million waste tires produced in the USA each year.



By using 100% recycled rubber C-PORT products, you can help our world move toward a more sustainable future.

KEY FEATURES AND BENEFITS

Features include:

- **100% Recycled Rubber**
- **Compatible with most rooftop materials**
- **Dampens vibrations**
- **No need for supplemental rubber pad**
- **Will not float**
- **Will not deteriorate**
- **Extensive product line for all of your rooftop needs**

Our product line has systems to support the following:

- **Pipe supports**
- **HVAC supports**
- **Roof Walkway supports**
- **Duct supports**
- **Conduit supports**
- **Air Conditioning supports**
- **Underfloor applications**
- **Solar Racking**



Environmentally Friendly
 made from 100% recycled tires



MIFAB's factory in Chicago, Illinois

C-PORT products are protected by one or more patents or patent pending applications in the United States including U.S. Patent Nos. 7,866,093 and 7,168,210.

PICTORIAL INDEX

 <p>CXM-B, CXH & C5-B - SMALL RUBBER SUPPORT SERIES (PAGE 2)</p>	 <p>CXP - RUBBER SUPPORT SERIES (PAGE 2)</p>	 <p>C - RUBBER SUPPORT SERIES WITH 13/16" GALVANIZED STEEL CHANNEL (PAGE 3)</p>	 <p>C5 & C6 - RUBBER SUPPORT SERIES WITH 1 5/8" GALVANIZED STEEL CHANNEL (PAGE 3)</p>
 <p>CXW - WIDEBODY RUBBER SUPPORT (PAGE 4)</p>	 <p>CW - WIDEBODY SERIES WITH 1 5/8" x 13/16" GALVANIZED CHANNEL (PAGE 4)</p>	 <p>CGW-E and CGW-T - W DEBODY GASKET SERIES (PAGE 5)</p>	 <p>CE - EXTENSION SERIES (PAGE 6)</p>
 <p>CEW - W DEBODY EXTENSION SERIES (PAGE 6)</p>	 <p>CRM - ROLLER SERIES, SMALL BASE (PAGE 7)</p>	 <p>CR - ROLLER SERIES, REGULAR BASE (PAGE 7)</p>	 <p>CRE - EXTENDED ROLLER SERIES, REGULAR BASE (PAGE 8)</p>
 <p>CREW - EXTENDED ROLLER SERIES, W DEBODY BASE (PAGE 8)</p>	 <p>CB - BRIDGE SUPPORT SERIES w/ TWO CX SERIES SUPPORTS AND 1 5/8" GALVANIZED CHANNEL (PAGE 9)</p>	 <p>CES - MEDIUM LOAD SERIES (PAGE 9)</p>	 <p>CESHW - WIDEBODY, HEAVY LOAD SERIES (PAGE 10)</p>
 <p>CESW - W DEBODY, WATER AND STEAM SUPPORT, MEDIUM LOAD SERIES (PAGE 11)</p>	 <p>CESWX - DOUBLE W DEBODY, WATER AND STEAM SUPPORT, HEAVY DUTY SERIES (PAGE 12)</p>	 <p>CESWXX - QUADRUPLE W DEBODY, WATER AND STEAM SUPPORT, EXTRA HEAVY DUTY SERIES (PAGE 12)</p>	 <p>DSA10 - DUCT SUPPORT SERIES (PAGE 13)</p>
 <p>DSAW - WIDEBODY, DUCT SUPPORT SERIES (PAGE 13)</p>	 <p>CS - 1 5/8" STEEL CHANNEL SERIES w/ 6" ADJUSTABLE 1 7/8" x 1 7/8" SQUARE LEG (PAGE 14)</p>	 <p>CZ - SEISMIC SERIES (PAGE 14)</p>	 <p>AP - A RPORT SUPPORT SYSTEM (PAGE 15)</p>
 <p>CSE - COPPER TUBE AND STEEL PIPE SUPPORT (PAGE 15)</p>	 <p>CC - COPPER PIPING SUPPORT (PAGE 16)</p>	 <p>CP - PLATFORM SERIES (PAGE 16)</p>	 <p>C-PORT LOADING CHART (Lbs./inch²) (PAGE 17)</p>

Design and dimensions are subject to modification. Prices do not include applicable taxes. Visit www.mifab.com for the most recent product information.

MIFAB®, Inc., 1321 West 119th Street, Chicago, Illinois 60643-5109, USA All sales subject to MIFAB's® Terms and Warranties. Please refer to inside front cover.

CXM-B, C5-B & CXH - SMALL RUBBER SUPPORT SERIES



Environmentally Friendly
 made from 100% recycled tires

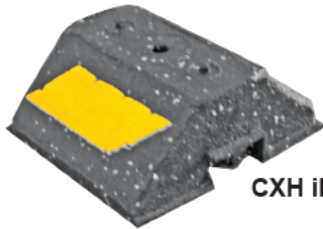

CXH illustrated

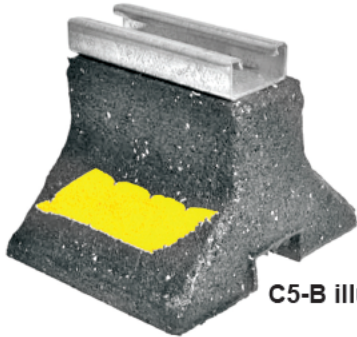

C5-B illustrated

Specification:

Dimensions - see chart

Material

Base - 100% recycled rubber, UV resistant
 Strut (on C5-B) - 14 gauge galvanized steel

(1 5/8" wide x 7/8" tall)

Maximum Load

CXM-B - 150 lbs.

C5-B - 300 lbs.

CXH - 150 lbs.

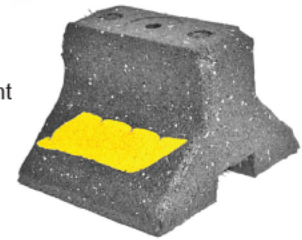

CXM-B illustrated.
 See page 20 for pipe clamps sold separately.

Function: The CXM-B, C5-B and CXH Series provide an economic alternative. They are perfect for supporting conduit or smaller pipe.

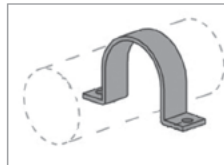

Pipe strap clamps for CXM-B sold separately. See page 20

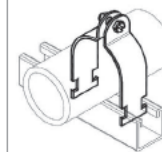

Strut Clamps for C5-B sold separately. See page 20

MODEL #	OVERALL HEIGHT (H1)*	BASE HEIGHT (H2)**	WIDTH (W)	LENGTH (L)	WEIGHT	LIST PRICE	CRATE QUANTITY
CXM-B	4" (102)	-	5" (127)	5" (127)	1.87 lbs.	\$10.50	800
C5-B	4 7/8" (124)	4" (102)	6" (152)	5" (127)	2.27 lbs.	\$14.50	750
CXH	2 1/4" (57")	-	5" (127)	5" (127)	1.00 lbs	\$7.50	-

*H1 - Overall height is from bottom of rubber support to top of the strut

**H2 - Base height is from bottom of rubber support to top of the rubber support

CXP - RUBBER SUPPORT SERIES



Environmentally Friendly
 made from 100% recycled tires



U.S. Patent
 No. 7,866,093

Specification:

Dimensions - see chart

Material

Base - 100% recycled rubber, UV resistant

Maximum Load

CXP - 500 lbs.

CXP-2 - 800 lbs.

Function: The CXP Series supports provide an economic alternative. They are ideal for supporting conduit or pipe. Strut and clamps by others.



Pipe strap clamps for CXP sold separately. See page 20

CXP illustrated. See page 20 for pipe clamps sold separately.

MODEL #	HEIGHT (H)	WIDTH (W)	LENGTH (L)	WEIGHT	LIST PRICE	CRATE QUANTITY
CXP	4" (102)	6" (152)	9.6" (244)	4.56 lbs.	\$18.50	340
CXP-2	4" (102)	6" (152)	22" (559)	10.84 lbs.	\$44.00	170

C - RUBBER SUPPORT SERIES WITH 13/16" GALVANIZED STEEL CHANNEL

Specification:

Base with 14 gauge Galvanized Channel (13/16" high)

Dimensions - 4 7/8" High x 6" Wide x 9.6" to 48" Length (See Chart)

Material - 100% recycled rubber, UV resistant

Maximum Load - 750 lbs. - for each 9.6" long support



Environmentally Friendly
made from 100% recycled
tires

Function: C Series channel support is designed for superior support of gas and refrigeration piping systems, cable tray, electrical conduit, multiple lines, HVAC equipment and many other applications. It is UV resistant and suitable for installation on most types of roofing material or other flat surfaces. Can be used as a curb (sleeper) replacement.

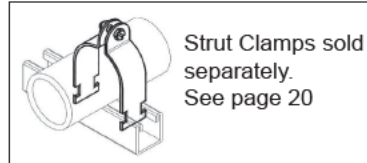
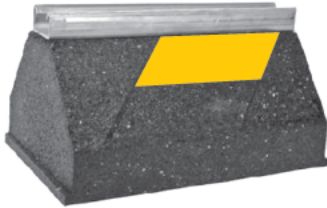

Strut Clamps sold separately.
See page 20

U.S. Patent No. 7,866,093



Note: C10 illustrated

MODEL #	OVERALL HEIGHT (H1)*	HEIGHT (H2)**	WIDTH (W)	LENGTH (L)	WEIGHT	LIST PRICE	CRATE QUANTITY
C10	4 7/8" (124)	4" (102)	6" (152)	9.6" (244)	5.30 lbs.	\$22.00	340
C20	4 7/8" (124)	4" (102)	6" (152)	19.2" (488)	11.23 lbs.	\$51.00	170
C30	4 7/8" (124)	4" (102)	6" (152)	28.8" (732)	16.31 lbs.	\$81.00	-
C40	4 7/8" (124)	4" (102)	6" (152)	38.5" (978)	21.72 lbs.	\$107.50	-
C48	4 7/8" (124)	4" (102)	6" (152)	48" (1219)	27.12 lbs.	\$164.50	-

*H1 - Overall height is from bottom of rubber support to top of the strut

**H2 - Base height is from bottom of rubber support to top of the rubber support

C5 & C6 - RUBBER SUPPORT SERIES WITH 1 5/8" GALVANIZED STEEL CHANNEL

Specification:

Dimensions

C510 - 5 5/8" Height x 6" Width x 9.6" Length

C610 to C640 - 6 1/8" Height x 6" Width x 9.6" to 38.5" Length

Material

Base - 100% recycled rubber, UV resistant

Channel - 14 gauge galvanized steel (1 5/8" wide x 1 5/8" high)

Maximum Load - 750 lbs. - for each 9.6" long support



Environmentally Friendly
made from 100% recycled
tires

U.S. Patent
No. 7,866,093

Function: The C5 Series and C6 Series are designed for superior support of gas and refrigeration piping systems, cable tray, electrical conduit, multiple lines, HVAC equipment and many other applications. Both series provide additional height, beyond the capability of the original C Series. The C6 Series is applicable where building codes require pipes to be at least 6" above the roof surface.

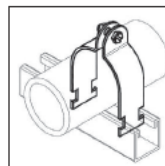

Strut Clamps sold separately.
See page 20

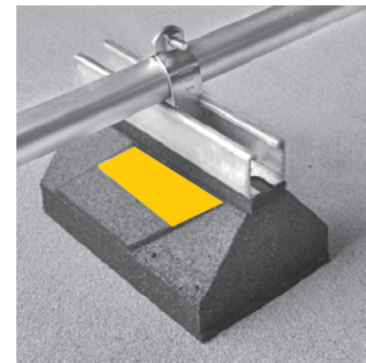

Note: C610 illustrated. See page 20 for pipe clamps sold separately.

MODEL #	OVERALL HEIGHT (H1)*	HEIGHT (H2)**	WIDTH (W)	LENGTH (L)	WEIGHT	LIST PRICE	CRATE QUANTITY
C510	5 5/8" (143)	4" (102)	6" (152)	9.6" (244)	6.25 lbs.	\$38.00	-
C610	6 7/16" (164)	4.50" (114)	6" (152)	9.6" (244)	6.67 lbs.	\$34.50	250
C620	6 7/16" (164)	4.50" (114)	6" (152)	19.2" (488)	13.34 lbs.	\$66.00	-
C630	6 7/16" (164)	4.50" (114)	6" (152)	28.8" (732)	20.01 lbs.	\$97.50	-
C640	6 7/16" (164)	4.50" (114)	6" (152)	38.5" (978)	26.68 lbs.	\$129.50	-

*H1 - Overall height is from bottom of rubber support to top of the strut

**H2 - Base height is from bottom of rubber support to top of the rubber support

CXW - WIDEBODY RUBBER SUPPORT



Environmentally Friendly
made from 100% recycled
tires

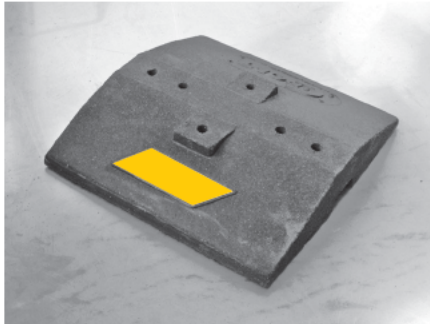

Note: CXW12 illustrated

Specification:

Dimensions - 2.50" Height x 12" Width x Length as specified in chart

Material

Base - 100% recycled rubber, UV resistant

Maximum Load - 1,200 lbs. - for each 12" long support

Function: The CXW Series is designed for superior support of gas and refrigeration piping systems, cable tray, electrical conduit, multiple lines, HVAC equipment and many other applications. The wide body of the base gives this support series superior stability and load bearing capability. It is suitable for most types of roofing material or other flat surfaces. Strut and clamps by others.

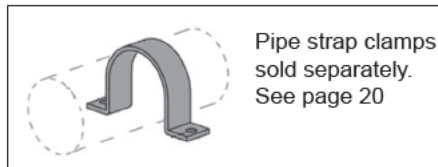

Pipe strap clamps
sold separately.
See page 20

Consult with roofing
consultant for allowable
loads

MODEL #	HEIGHT (H)	WIDTH (W)	LENGTH (L)	WEIGHT	LIST PRICE
CXW12	2.5" (63)	12" (305)	12" (305)	9.56 lbs.	\$36.50
CXW24	2.5" (63)	12" (305)	24" (610)	19.12 lbs.	\$73.00
CXW36	2.5" (63)	12" (305)	36" (914)	28.68 lbs.	\$109.50

CW - WIDEBODY SERIES WITH 1 5/8" x 13/16" GALVANIZED CHANNEL



Environmentally Friendly
made from 100% recycled
tires

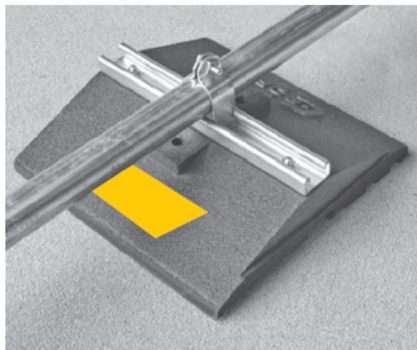

Note: CW12 illustrated. See page 20
for pipe clamps sold separately.

Specification:

Dimensions - 3.3125" Height x 12" Width x Length as specified in chart

Material

Base - 100% recycled rubber, UV resistant

Strut - 14 gauge galvanized steel

Maximum Load - 1,200 lbs. - for each 12" long support

Function: The CW Series is designed for superior support of gas and refrigeration piping systems, cable tray, electrical conduit, multiple lines, HVAC equipment and many other applications. The wide body of the base gives this support series superior stability and load-bearing capability. It is suitable for most types of roofing material or other flat surfaces.

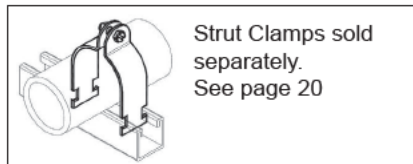

Strut Clamps sold
separately.
See page 20

Consult with roofing
consultant for allowable
loads

MODEL #	OVERALL HEIGHT (H1)*	HEIGHT (H2)**	WIDTH (W)	LENGTH (L)	WEIGHT	LIST PRICE
CW12	3.3125" (84)	2.50" (63)	12" (305)	12" (305)	9.5 lbs.	\$45.50
CW24	3.3125" (84)	2.50" (63)	12" (305)	24" (610)	19.0 lbs.	\$91.00
CW36	3.3125" (84)	2.50" (63)	12" (305)	36" (914)	28.5 lbs.	\$136.00
CW48	3.3125" (84)	2.50" (63)	12" (305)	48" (1219)	38.0 lbs.	\$182.00
CW60	3.3125" (84)	2.50" (63)	12" (305)	60" (1524)	47.5 lbs.	\$227.00
CW72	3.3125" (84)	2.50" (63)	12" (305)	72" (1829)	57.0 lbs.	\$272.50

*H1 - Overall height is from bottom of rubber support to top of the strut

**H2 - Base height is from bottom of rubber support to top of the rubber support

CGW-E – WIDEBODY GASKET SERIES – WITH EPDM MEMBRANE

Specification:

Dimensions

3.3125" Height x 12" Width x Length as specified in chart

EPDM Gasket - 24" Wide x Length as specified in chart

Material

Base - 100% recycled rubber, UV resistant

Strut - 14 gauge galvanized steel

Maximum Load - 1,200 lbs. - for each 12" long support

Function: The CGW-E Series channel support is designed for superior support of gas and refrigeration piping systems, cable trays, electrical conduit, multiple lines, HVAC equipment and many other applications. The wide body of the base gives this support series superior stability and load-bearing capacity. The Gasket Series can be glued down to the roof, and the EPDM gasket provides an extra protective barrier between the rubber base and roof surface.

PATENT PENDING



Environmentally Friendly
made from 100% recycled tires

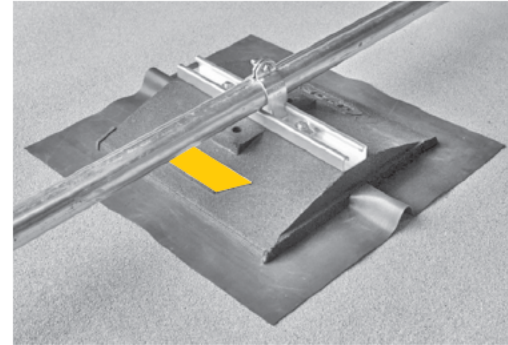

Note: CGW-E-12 illustrated. See page 20 for pipe clamps sold separately.

Consult with roofing consultant for allowable loads

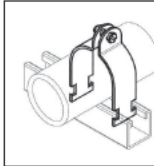

Strut Clamps sold separately. See page 20

MODEL #	OVERALL HEIGHT (H1)*	HEIGHT (H2)**	C-PORT WIDTH (W)	C-PORT LENGTH (L)	WIDTH (W) (with gasket)	LENGTH (L) (with gasket)	WEIGHT	LIST PRICE
CGW-E-12	3.3125" (84)	2.50" (63)	12" (305)	12" (305)	18" (457)	18" (457)	9.5 lbs.	\$71.00
CGW-E-24	3.3125" (84)	2.50" (63)	12" (305)	24" (610)	18" (457)	36" (914)	19.0 lbs.	\$142.00
CGW-E-36	3.3125" (84)	2.50" (63)	12" (305)	36" (914)	18" (457)	54" (1372)	28.5 lbs.	\$213.00
CGW-E-48	3.3125" (84)	2.50" (63)	12" (305)	48" (1219)	18" (457)	72" (1829)	38.0 lbs.	\$283.50

*H1 - Overall height is from bottom of rubber support to top of the strut

**H2 - Base height is from bottom of rubber support to top of the rubber support Channel also available in corrosion resistant stainless steel or aluminum.

CGW-T – WIDEBODY GASKET SERIES – WITH TPO MEMBRANE

Specification:

Dimensions

3.3125" Height x 12" Width x Length as specified in chart

TPO Gasket - 24" Wide x Length as specified in chart

Material

Base - 100% recycled rubber, UV resistant

Strut - 14 gauge galvanized steel

Maximum Load - 1,200 lbs. - for each 12" long support

Function: The CGW-T Series channel support is designed for superior support of gas and refrigeration piping systems, cable trays, electrical conduit, multiple lines, HVAC equipment and many other applications. The wide body of the base gives this support series superior stability and load-bearing capacity. The Gasket Series can be glued down to the roof, and the TPO gasket provides an extra protective barrier between the rubber base and roof surface.

PATENT PENDING



Environmentally Friendly
made from 100% recycled tires

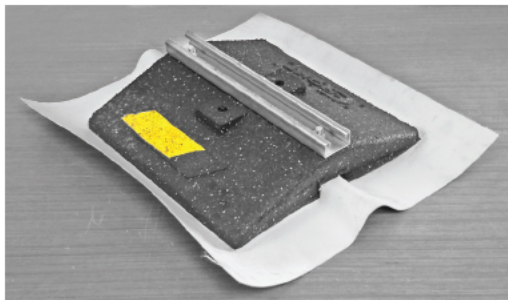

Note: CGW-T-12 illustrated. See page 20 for pipe clamps sold separately.

Consult with roofing consultant for allowable loads

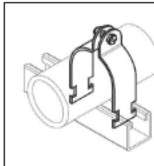

Strut Clamps sold separately. See page 20

MODEL #	OVERALL HEIGHT (H1)*	HEIGHT (H2)**	C-PORT WIDTH (W)	C-PORT LENGTH (L)	WIDTH (W) (with gasket)	LENGTH (L) (with gasket)	WEIGHT	LIST PRICE
CGW-T-12	3.3125" (84)	2.50" (63)	12" (305)	12" (305)	18" (457)	18" (457)	9.5 lbs.	\$71.00
CGW-T-24	3.3125" (84)	2.50" (63)	12" (305)	24" (610)	18" (457)	36" (914)	19.0 lbs.	\$142.00
CGW-T-36	3.3125" (84)	2.50" (63)	12" (305)	36" (914)	18" (457)	54" (1372)	28.5 lbs.	\$213.00
CGW-T-48	3.3125" (84)	2.50" (63)	12" (305)	48" (1219)	18" (457)	72" (1829)	38.0 lbs.	\$283.50

*H1 - Overall height is from bottom of rubber support to top of the strut

**H2 - Base height is from bottom of rubber support to top of the rubber support Channel also available in corrosion resistant stainless steel or aluminum.

CE - EXTENSION SERIES



Environmentally Friendly
made from 100% recycled
tires



Specification:

Dimensions

Base - 4" Height x 6" Width x 9.6" Length
 Overall height as specified in chart

Material

Base - 100% recycled rubber, UV resistant
 Strut - 14 gauge galvanized steel (1 5/8" wide x 13/16" tall)
 Rod - Two 1/2" electro zinc plated all threaded rod risers

Maximum Load - 400 lbs.

Function: The CE Series is designed for extended support of gas and refrigeration piping systems, cable tray, electrical conduit, multiple lines, HVAC equipment and many other applications. It is suitable for most types of roofing material or other flat surfaces.

Installation Instructions: The rubber bases can be directly placed on most roof surfaces. Adjust the crossbeam by loosening the nuts and adjust the strut to desired height and re-tighten nuts. Space the bases according to local plumbing/gas code. A wide range of pipe clamps and straps can be used with this support.

Consult with roofing consultant for allowable loads

Strut Clamps sold separately. See page 20

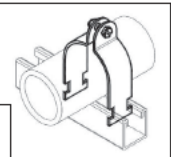

Note: CE10-8 illustrated. See page 20 for pipe clamps sold separately.

MODEL #	HEIGHT (H)	WIDTH (W)	LENGTH (L)	WEIGHT	LIST PRICE	CRATE QUANTITY
CE10-8	8" (203)	6" (152)	9.6" (244)	6.14 lbs.	\$36.00	200
CE10-12	12" (305)	6" (152)	9.6" (244)	6.50 lbs.	\$44.50	160

U.S. Patent No. 7,866,093

Channel also available in corrosion resistant stainless steel or aluminum.

CEW - WIDEBODY EXTENSION SERIES



Environmentally Friendly
made from 100% recycled
tires

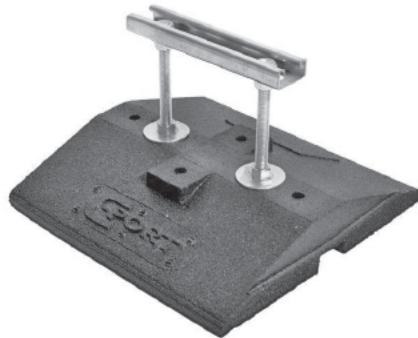

Specification:

Dimensions

Base - 2 1/2" Height x 12" Width x 12" Length
 Overall height as specified in chart

Material

Base - 100% recycled rubber, UV resistant
 Strut - 14 gauge galvanized steel (1 5/8" wide x 13/16" tall)
 Rod - Two 1/2" electro zinc plated all threaded rod risers

Maximum Load - 800 lbs.

Function: The CEW Series is designed for extended support of gas and refrigeration piping systems, cable tray, electrical conduit, multiple lines, HVAC equipment and many other applications. The wide-bodied base provides additional stability. It is suitable for most types of roofing material or other flat surfaces.

Installation Instructions: The rubber bases can be directly placed on approved roof surfaces. Adjust the crossbeam by loosening the nuts and adjust the strut to desired height and re-tighten nuts. Space the bases according to local plumbing/gas code.

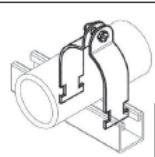

Strut Clamps sold separately. See page 20

Consult with roofing consultant for allowable loads

Note: CEW12-8 illustrated. See page 20 for pipe clamps sold separately.

MODEL #	HEIGHT (H)	WIDTH (W)	LENGTH (L)	WEIGHT	LIST PRICE	CRATE QUANTITY
CEW12-8	8" (203)	12" (305)	12" (305)	10.50 lbs.	\$58.50	90
CEW12-12	12" (305)	12" (305)	12" (305)	10.90 lbs.	\$61.00	90
CEW12-16	16" (406)	12" (305)	12" (305)	11.20 lbs.	\$64.00	80
CEW12-24	24" (610)	12" (305)	12" (305)	11.45 lbs.	\$69.00	-

Channel also available in corrosion resistant stainless steel or aluminum.

CRM-B - ROLLER SERIES, SMALL BASE

Specification:

Material

Base - 100% recycled rubber, UV resistant

Roller - rubber

Maximum Load - 300 lbs.

Function: The CRM-B Series is designed for superior support of gas and refrigeration pipes at a higher elevation from the roof surface. The roller allows for longitudinal movements of the pipe. The CRM provides a less expensive alternative to the larger roller series products. It is suitable for most types of roofing material or other flat surfaces, and is ideal for smaller pipes. The roller bracket has roller mounting holes 1" apart so that the roller can be adjusted to 6 1/4" or 7 1/4" from the centerline to the ground.



Environmentally Friendly
made from 100% recycled
tires

PATENT
PENDING



MODEL #	PIPE SIZE (OD)	OVERALL HEIGHT (H) TO ROLLER CENTRE (ADJUSTABLE)	WIDTH (W)	LENGTH (L)	WEIGHT	LIST PRICE
CRM-B-3	Up to 3" Pipe	6 1/4" (159) or 7 1/4" (189)	6" (152)	4.5" (114)	3.05 lbs.	\$32.00
CRM-B-4	Up to 4" Pipe	6 1/4" (159) or 7 1/4" (189)	6" (152)	4.5" (114)	3.05 lbs.	\$34.00

CR - ROLLER SERIES, REGULAR BASE

Specification:

Dimensions

Base - Width of 6" x Length of 9.6"

Roller Width - 3", 4", or 6" rollers are available (See Chart)

Total Height to Roller Centre - 6" or 7" (See Chart)

Material

Base - 100% recycled rubber, UV resistant

Roller - rubber (cast iron galvanized rollers for 6" pipe are also available)

Maximum Load - 500 lbs.

Function: The CR Series is designed for superior support of gas and refrigeration pipes. The roller allows for longitudinal movements of the pipe. This support is suitable for most types of roofing material or other flat surfaces. The roller bracket has roller mounting holes 1" apart so that the roller can be adjusted to 6" or 7" from the centerline to the ground.



Environmentally Friendly
made from 100% recycled
tires

PATENT
PENDING



Note: CR10-4 illustrated

MODEL #	PIPE SIZE (OD)	OVERALL HEIGHT (H) TO ROLLER CENTRE (ADJUSTABLE)	WIDTH (W)	LENGTH (L)	WEIGHT	LIST PRICE
CR10-3	Up to 3" Pipe	6" (152) or 7" (178)	6" (152)	9.6" (244)	6.10 lbs.	\$43.00
CR10-4	Up to 4" Pipe	6" (152) or 7" (178)	6" (152)	9.6" (244)	6.44 lbs.	\$44.50

Also available with a 3" or 4" rubber roller, or a 6" cast iron galvanized roller.

CRE - EXTENDED ROLLER SERIES, REGULAR BASE



Environmentally Friendly made from 100% recycled tires

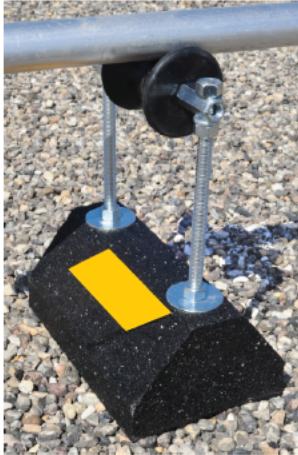

Specification: Dimensions

Base - Width of 6" x Length of 9.6"
 Roller Width - 3", 4", or 6" rollers are available (See Chart)
 Total Height to Roller Centre - ranges from 8" to 12" (See Chart)

Material

Base - 100% recycled rubber, UV resistant
 Roller - rubber (cast iron galvanized rollers for 6" pipe are also available)

Extending Rods and Horizontal Rod - 1/2" electro zinc plated all threaded rod risers

Maximum Load - 300 lbs.

Function: The CRE Series is designed for superior support of gas and refrigeration pipes at a higher elevation from the roof surface. The roller allows for longitudinal movements of the pipe. This support is suitable for most types of roofing material or other flat surfaces.

Note: CRE10-12-3 illustrated

U.S. Patent No. 7,866,093

Consult with roofing consultant for allowable loads

MODEL #	PIPE SIZE (OD)	OVERALL HEIGHT (H) TO ROLLER CENTRE	WIDTH (W)	LENGTH (L)	WEIGHT	LIST PRICE
CRE10-12-3	Up to 3" Pipe	12" (305)	6" (152)	9.6" (244)	7.10 lbs.	\$62.00
CRE10-12-4	Up to 4" Pipe	12" (305)	6" (152)	9.6" (244)	7.50 lbs.	\$63.00

Also available with a 3" or 4" rubber roller, or a 6" cast iron galvanized roller (except for CRM).

CREW - EXTENDED ROLLER SERIES, WIDEBODY BASE



Environmentally Friendly made from 100% recycled tires

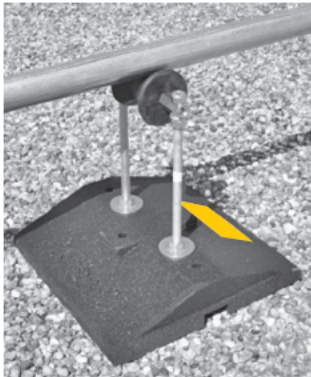

Specification: Dimensions

Base - 12" Width x 12" Length
 Roller Width - 3", 4", or 6" (See Chart)
 Total Height to Roller Centre - 12" or 16" (See Chart)

Material

Base - 100% recycled rubber, UV resistant
 Roller - rubber (cast iron galvanized rollers for 6" pipe are also available)

The extending rods, as well as the horizontal rod that the roller rests on, are all 1/2" electro zinc plated all threaded rod risers

Maximum Load - 500 lbs.

Function: The CREW Series support is designed for superior support of gas and refrigeration pipes. The roller allows for longitudinal movements of the pipe. The wide-bodied base provides additional stability and load-bearing capacity. This support is suitable for most types of roofing material or other flat surfaces.

Note: CREW12-12-3 illustrated

Consult with roofing consultant for allowable loads

MODEL #	PIPE SIZE (OD)	OVERALL HEIGHT (H) TO ROLLER CENTRE	WIDTH (W)	LENGTH (L)	WEIGHT	LIST PRICE
CREW12-12-3	Up to 3"	12" (305)	12" (305)	12" (305)	11.3 lbs.	\$81.50
CREW12-12-4	3" to 4"	12" (305)	12" (305)	12" (305)	11.5 lbs.	\$83.50
CREW12-12-6	4" to 6"	12" (305)	12" (305)	12" (305)	13.0 lbs.	\$99.50
CREW12-16-3	Up to 3"	16" (406)	12" (305)	12" (305)	11.5 lbs.	\$84.50
CREW12-16-4	3" to 4"	16" (406)	12" (305)	12" (305)	11.7 lbs.	\$86.50
CREW12-16-6	4" to 6"	16" (406)	12" (305)	12" (305)	13.5 lbs.	\$107.00

Also available with a 3" or 4" rubber roller, or a 6" cast iron galvanized roller.

CB - BRIDGE SUPPORT SERIES w/ TWO CX SERIES SUPPORTS AND 1 5/8" GALVANIZED CHANNEL

Specification:

Two (2) Bases Bridged with 14 gauge Galvanized Channel (1 5/8" high)

Dimensions - 5 5/8" High x 6" Wide x Bridge Length (Overall Length)

Material - 100% recycled rubber, UV resistant

Load Rating - Each base rated at 500 lbs. Refer to beam load of channel at various lengths as other factor (see Strut catalog)



Environmentally Friendly
made from 100% recycled
tires

Function: CB Bridge channel is designed as a superior sleeper for HVAC equipment, cable tray, roof walkway systems, refrigeration equipment and many other applications. It is UV resistant and suitable for installation on most types of roofing material or other flat surfaces.

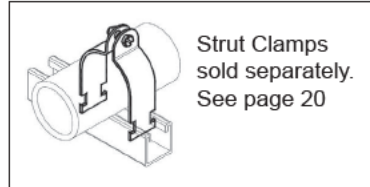

Strut Clamps
sold separately.
See page 20

U.S. Patent
No. 7,866,093



Note: See page 19 for pipe clamps sold separately.

MODEL #	OVERALL HEIGHT (H1)*	HEIGHT (H2)**	CURB LENGTH (L)	STRUT LENGTH (L)	WEIGHT	LIST PRICE
CB10-28	5 5/8" (143)	4" (102)	9.6" (244)	28" (711)	13.59 lbs.	\$64.00
CB10-36	5 5/8" (143)	4" (102)	9.6" (244)	36" (914)	14.88 lbs.	\$70.00
CB10-42	5 5/8" (143)	4" (102)	9.6" (244)	42" (1067)	15.66 lbs.	\$73.00
CB10-50	5 5/8" (143)	4" (102)	9.6" (244)	50" (1270)	17.24 lbs.	\$77.00
CB10-60	5 5/8" (143)	4" (102)	9.6" (244)	60" (1524)	18.79 lbs.	\$83.50

*H1 - Overall height is from bottom of rubber support to top of the strut

**H2 - Base height is from bottom of rubber support to top of the rubber support
Channel also available in corrosion resistant stainless steel or aluminum.

Consult with roofing consultant
for allowable loads

CES - MEDIUM LOAD SERIES

Specification:

Dimensions - 10" High x 9.6" Base Length x 12" to 24" Crossbeam Width (See Chart)

Material

Base - 100% recycled rubber, UV resistant

Crossbeam and Uprights - 1 5/8" x 1 5/8", 14 gauge galvanized steel strut

Maximum Load - 500 lbs.



Environmentally Friendly
made from 100% recycled
tires

Function: The CES Series can support gas and refrigeration piping systems, cable tray, electrical conduit, multiple lines, HVAC equipment and many other applications. It is designed for rooftop applications requiring a heavier load bearing, and is suitable for most types of roofing material or other flat surfaces.

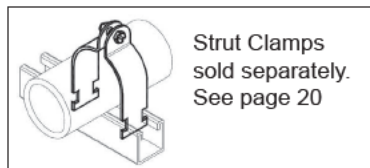

Strut Clamps
sold separately.
See page 20

U.S. Patent
No. 7,866,093

Note: CES10-1012 illustrated.

Consult with roofing consultant for
allowable loads

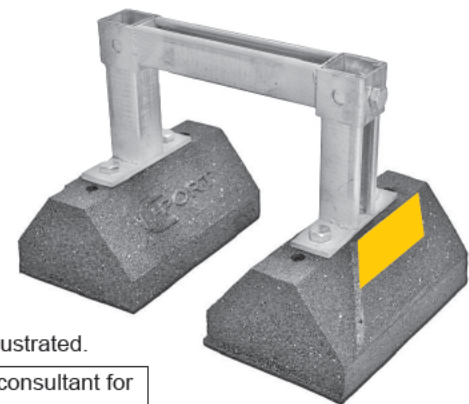

MODEL #	HEIGHT (H)	CROSSBEAM WIDTH	BASE WIDTH	BASE LENGTH	WEIGHT	LIST PRICE
CES10-1012	10" (254)	12" (305)	6" (152)	9.6" (244)	14.21 lbs.	\$138.00
CES10-1024	10" (254)	24" (610)	6" (152)	9.6" (244)	15.62 lbs.	\$149.50

Channel also available in corrosion resistant stainless steel or aluminum.

CESHW - WIDEBODY, HEAVY LOAD SERIES

Specification:

Dimensions

Base - 12" Width x 12" Length

Material

Rubber Base - 100% recycled rubber, UV resistant

Base Strut - 14 gauge galvanized steel

Crossbeam - 1 5/8" x 3 1/4", 12 gauge galvanized steel, back to back strut

Upright - 1 5/8" x 1 5/8", 12 gauge galvanized steel strut

Maximum Load - 1,200 lbs.

Function: The CESHW Series can support gas and refrigeration piping systems, cable tray, electrical conduit, multiple lines, HVAC equipment and many other applications. It is designed for rooftop applications requiring a heavier load bearing, and is suitable for most types of roofing material or other flat surfaces.



Environmentally Friendly made from 100% recycled tires

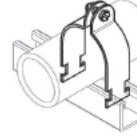

Strut Clamps sold separately. See page 20

Consult with roofing consultant for allowable loads

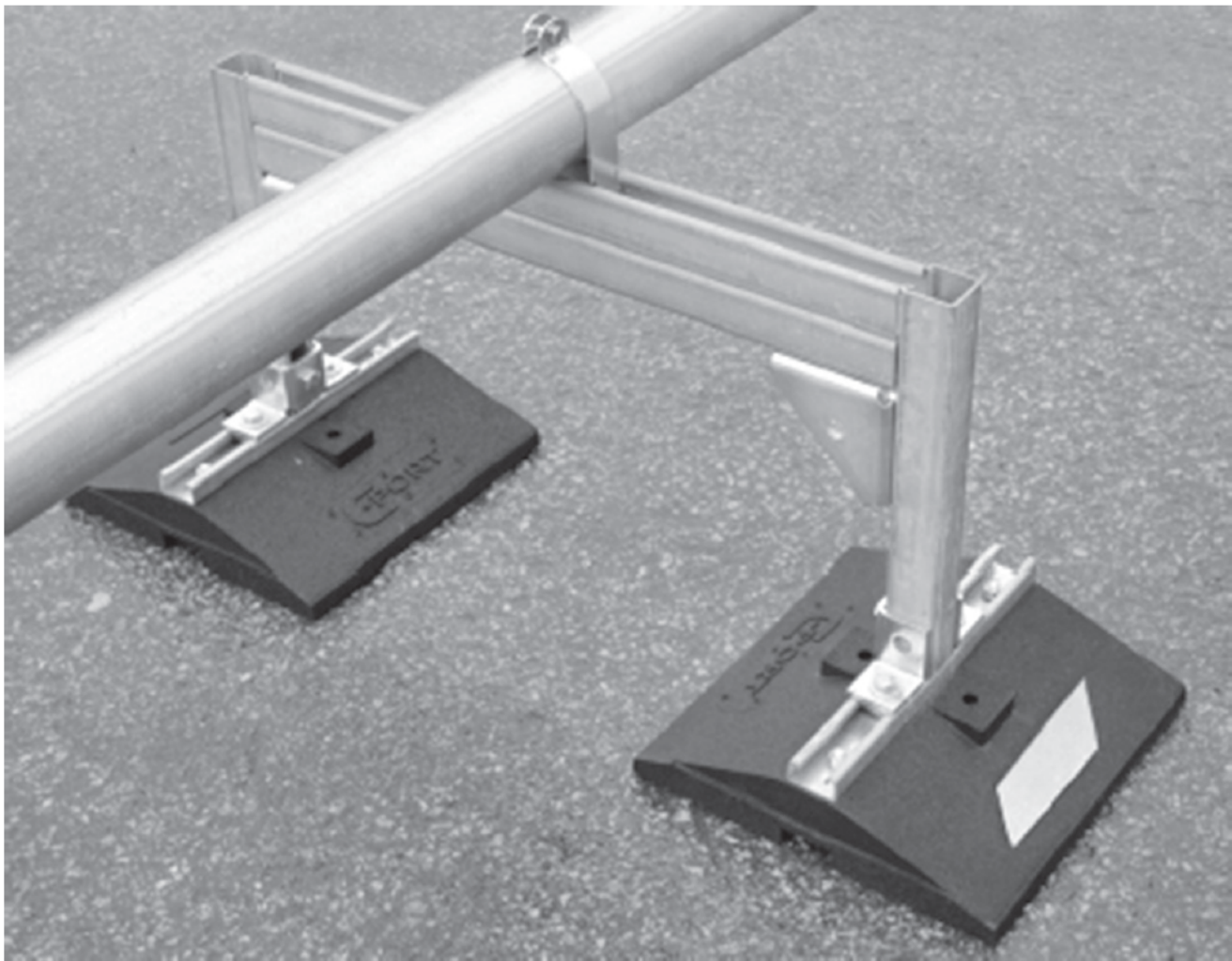

Note: CESHW-1624 illustrated. See page 20 for pipe clamps sold separately.

MODEL #	HEIGHT (H)	WIDTH (W)	BASE HEIGHT & WIDTH	WEIGHT	LIST PRICE
CESHW-1624	16" (406)	24" (610)	12" (305)	37 lbs.	\$324.00
CESHW-1636	16" (406)	36" (914)	12" (305)	39 lbs.	\$351.00

Channel also available in corrosion resistant stainless steel or aluminum.

CESW - WIDEBODY, WATER AND STEAM SUPPORT, MEDIUM LOAD SERIES

Specification:

Dimensions - 24" Crossbeam Width x 12" Base Length x 24" to 48" Height (See Chart)

Material

Base - 100% recycled rubber, UV resistant
 Crossbeam and Uprights - 1 5/8" x 1 5/8", 12 gauge galvanized steel slotted strut

Maximum Load - 600 lbs.



Environmentally Friendly
 made from 100% recycled tires

Function: The CESW Series can support gas and refrigeration piping systems, cable tray, electrical conduit, multiple lines, HVAC equipment and many other applications. It is designed for rooftop applications requiring a heavier load bearing, and is suitable for most types of roofing material or other flat surfaces. The wide bases provide this series with added stability. The CESW Series is suitable for use with one or two pipe hangers (by others).

Consult with roofing consultant for allowable loads



Note: CESW12-2424 illustrated. Pipe hangers by others.

MODEL #	HEIGHT (H)	CROSSBEAM WIDTH	BASE WIDTH	BASE LENGTH	WEIGHT	LIST PRICE
CESW12-2424	24" (610)	24" (610)	12" (305)	12" (305)	27.80 lbs.	\$260.50
CESW12-3624	36" (914)	24" (610)	12" (305)	12" (305)	31.12 lbs.	\$276.50
CESW12-4824	48" (1219)	24" (610)	12" (305)	12" (305)	34.44 lbs.	\$293.00

Channel also available in corrosion resistant stainless steel or aluminum.

CESWX - DOUBLE WIDEBODY, WATER AND STEAM SUPPORT, HEAVY DUTY SERIES



Environmentally Friendly
made from 100% recycled tires



Specification:

Dimensions: 24" Crossbeam Width x 24" Base Length x 24" to 48" Height (See Chart)

Pipe Size: Maximum pipe size – 8". Pipe clearance from roof is 6" to 36"

Material:

Base – 100% recycled rubber, UV resistant

Crossbeam and Uprights – 1 5/8" x 1 5/8", 12 gauge galvanized steel slotted strut.

Maximum Load: 700 lbs.

Function: The CESWX Series can support gas and refrigeration piping systems, cable tray, electrical Conduit multiple lines, HVAC equipment and many other applications. It is designed for rooftop applications requiring a heavier load bearing, and it is suitable for most types of roofing material or other flat surfaces. The 12" x 24" base area provides this Series with added stability and load bearing. The CESWX Series is suitable for use with one or two pipe hangers (by others).

Note: CESWX24-2424 illustrated.
Pipe hangers by others.

MODEL #	HEIGHT (H)	CROSSBEAM WIDTH (W)	BASE WIDTH	BASE LENGTH (L)	WEIGHT	LIST PRICE
CESWX24-2424	24" (610)	24" (610)	12" (305)	24" (610)	47.00 lbs.	\$351.00
CESWX24-3624	36" (914)	24" (610)	12" (305)	24" (610)	51.00 lbs.	\$367.50
CESWX24-4824	48" (1219)	24" (610)	12" (305)	24" (610)	55.00 lbs.	\$384.50

Note: Uprights are not included. Strut can be cut to suit job site.
Channel also available in corrosion resistant stainless steel or aluminum.

Consult with roofing consultant for allowable loads

CESWXX - QUADRUPLE WIDEBODY, WATER AND STEAM SUPPORT, EXTRA HEAVY DUTY SERIES



Environmentally Friendly
made from 100% recycled tires



Specification:

Dimensions: 24" Crossbeam Width x 48" Base Length x 24" to 48" Height (See Chart)

Pipe Size: Maximum pipe size – 16" Inside Dimension, 18" Outside Dimension. Pipe clearance from roof is 6" to 36"

Material:

Base – 100% recycled rubber, UV resistant

Crossbeam and Uprights – 1 5/8" x 1 5/8", 12 gauge galvanized steel slotted strut.

Maximum Load: 1,600 lbs.

Function: The CESWXX Series can support gas and refrigeration piping systems, cable tray, electrical Conduit multiple lines, HVAC equipment and many other applications. It is designed for rooftop applications requiring a heavier load bearing, and it is suitable for most types of roofing material or other flat surfaces. The 48" x 12" base area provides this Series with added stability and load bearing. The CESWXX Series is suitable for use with one or two pipe hangers (by others).

Note: CESWXX24-2424 illustrated.
Pipe hangers by others.

Consult with roofing consultant for allowable loads

MODEL #	HEIGHT (H)	CROSSBEAM WIDTH (W)	BASE WIDTH	BASE LENGTH (L)	WEIGHT	LIST PRICE
CESWXX48-2424	24" (610)	24" (610)	12" (305)	48" (1219)	85.00 lbs.	\$551.50
CESWXX48-3624	36" (914)	24" (610)	12" (305)	48" (1219)	89.00 lbs.	\$577.50
CESWXX48-4824	48" (1219)	24" (610)	12" (305)	48" (1219)	93.00 lbs.	\$604.00

Note: Uprights are not included. Strut can be cut to suit job site.
Channel also available in corrosion resistant stainless steel or aluminum.

DSA10 - DUCT SUPPORT SERIES
Specification:
Telescopic Crossbeam

Outer Piece Dimensions - 1 7/8" x 1 7/8"

Inner Piece Dimensions - 1 5/8" x 1 5/8"

Material - 12 gauge galvanized steel

Vari-Angle Bracket

Dimensions - 5 7/8" x 1 7/8"

Material - 1/4" Hot-rolled, zinc plated carbon steel

Base (DSA10)

Dimensions - 4" Height x 6" Width x 9.6" Length

Maximum Load - 800 lbs.

Material (both models) - 100% recycled rubber, UV resistant

Function: The DSA Series is designed specifically for ductwork. The telescopic crossbeam allows for easy size adjustments. The bases feature vari-angle supports to adapt to any roof pitch and are made of 100% recycled rubber. Narrower bases are used with the DSA10 Series.

 Hardware is included for crossbeam and vertical strut.
 Crossbeam is included. Vertical strut is not included.

Consult with roofing consultant for allowable loads

Hardware:

1/2" X 1" bolts - 8 pieces

1/2" channel nuts - 8 pieces

Environmentally Friendly
 made from
100% recycled tires

Crossbeam is adjustable. See table below for Min. - Max. widths.

 U.S. Patent
 No. 7,866,093

Note: DSA10-1831 illustrated

MODEL #	WIDTH (W) MIN	WIDTH (W) MAX	BASE LENGTH (L)	WEIGHT	LIST PRICE
DSA10-1831	18" (457)	31" (787)	10" (254)	39.90 lbs.	\$232.50
DSA10-3157	31" (787)	57" (1448)	10" (254)	45.10 lbs.	\$264.00
DSA10-57102	57" (1448)	102" (2591)	10" (254)	50.10 lbs.	\$375.00

Note: **Uprights are not included.** Strut can be cut to suit job site.
 Channel also available in corrosion resistant stainless steel or aluminum.

DSAW - WIDEBODY, DUCT SUPPORT SERIES
Specification:
Telescopic Crossbeam

Outer Piece Dimensions - 1 7/8" x 1 7/8"

Inner Piece Dimensions - 1 5/8" x 1 5/8"

Material - 12 gauge, galvanized steel

Vari-Angle Bracket

Dimensions - 5 7/8" x 1 7/8"

Material - 1/4" Hot-rolled, zinc plated carbon steel

Base (DSAW)

Dimensions - 2 1/4" Height x 12" Width x 12" Length

Maximum Load - 1,000 lbs.

Material (both models) - 100% recycled rubber, UV resistant

Function: The DSAW Series is designed specifically for ductwork. The telescopic crossbeam allows for easy size adjustments. The bases feature vari-angle supports to adapt to any roof pitch and are made of 100% recycled rubber. Wide bases are used with the DSAW Series.

 Hardware is included for crossbeam and vertical strut.
 Crossbeam is included. Vertical strut is not included.

Consult with roofing consultant for allowable loads

Hardware:

1/2" X 1" bolts - 8 pieces

1/2" channel nuts - 8 pieces

Environmentally Friendly
 made from
100% recycled tires

Crossbeam is adjustable. See table below for Min. - Max. widths.



Note: DSAW-1831 illustrated

MODEL #	WIDTH (W) MIN	WIDTH (W) MAX	BASE LENGTH (L)	WEIGHT	LIST PRICE
DSAW-1831	18" (457)	31" (787)	12" (305)	29.90 lbs.	\$255.00
DSAW-3157	31" (787)	57" (1448)	12" (305)	35.10 lbs.	\$307.50
DSAW-57102	57" (1448)	102" (2591)	12" (305)	40.10 lbs.	\$435.00

Note: **Uprights are not included.** Strut can be cut to suit job site.
 Channel also available in corrosion resistant stainless steel or aluminum.

CS - 1 5/8" STEEL CHANNEL SERIES w/ 6" ADJUSTABLE 1 7/8" x 1 7/8" SQUARE LEG



Environmentally Friendly
made from 100% recycled tires



Specification:

Base with 12 gauge Galvanized Channel (1 5/8" high) and Adapter Leg
Dimensions - 5 5/8" High (not including height of adapter leg) x 6" Wide x Length (Base Length)

Material - 100% recycled rubber, UV resistant

Adapter Fitting - 1 7/8" x 1 7/8" channel with 9/16" holes on all three (3) sides.

Maximum Load - 750 lbs. - for each 9.6" long support



Function: CS Vari-Angle support is variable angle support designed for ventilation duct, walkway systems, HVAC equipment and many other applications installed on sloped or uneven surfaces. Adapter leg will accommodate 1 5/8" x 1 5/8" steel strut for framing. It is UV resistant and suitable for installation on most types of roofing material and sloped surfaces.

U.S. Patent No. 7,168,210

Note: CS10 illustrated.

MODEL #	OVERALL HEIGHT (H1)*	HEIGHT (H2)**	WIDTH (W)	LENGTH (L)	WEIGHT	LIST PRICE
CS10	5 5/8" (143)	4" (102)	6" (152)	9.6" (244)	7.97 lbs.	\$61.50
CS20	5 5/8" (143)	4" (102)	6" (152)	22" (558)	15.07 lbs.	\$93.50
CS30	5 5/8" (143)	4" (102)	6" (152)	28.8" (732)	20.29 lbs.	\$117.00
CS40	5 5/8" (143)	4" (102)	6" (152)	38.5" (978)	26.43 lbs.	\$145.50
CS48	5 5/8" (143)	4" (102)	6" (152)	48" (1219)	32.60 lbs.	\$174.50

*H1 - Overall height is from bottom of rubber support to top of the strut

**H2 - Base height is from bottom of rubber support to top of the rubber support

Channel also available in corrosion resistant stainless steel or aluminum.

U.S. Patent No. 7,866,093

CZ - SEISMIC SERIES



Environmentally Friendly
made from 100% recycled tires



Note: CZ10 illustrated.

Specification:

Dimensions - 4 7/8" High x 6" Wide x 9.6" to 38.5" Length (Base Length)

Materials

Base - 100% recycled rubber, UV resistant

Strut - 14 gauge Galvanized Channel

Rod - 1/2" electro zinc plated all threaded rod risers

Gasket - 3" x 3"

Maximum Load - 750 lbs. - for each 9.6" long support

Function: The CZ Seismic Series is designed for superior support of gas and refrigeration piping systems, cable tray, electrical conduit, multiple lines, HVAC equipment and many other applications. This is a penetrating support fastened to the structure under the membrane. It is ideally designed for hurricane resistance or seismic applications. It is suitable for most types of roofing material or other flat surfaces.

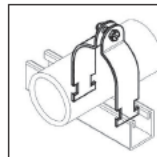

Strut Clamps sold separately. See page 20

U.S. Patent No. 7,866,093

MODEL #	OVERALL HEIGHT (H1)*	HEIGHT (H2)**	WIDTH (W)	LENGTH (L)	WEIGHT	LIST PRICE
CZ10	4 7/8" (124)	4" (102)	6" (152)	9.6" (244)	5.90 lbs.	\$42.50
CZ20	4 7/8" (124)	4" (102)	6" (152)	19.2" (488)	11.83 lbs.	\$83.00
CZ30	4 7/8" (124)	4" (102)	6" (152)	28.8" (732)	16.91 lbs.	\$99.50
CZ40	4 7/8" (124)	4" (102)	6" (152)	38.5" (978)	22.32 lbs.	\$139.00

*H1 - Overall height is from bottom of rubber support to top of the strut

**H2 - Base height is from bottom of rubber support to top of the rubber support

Channel also available in corrosion resistant stainless steel or aluminum. **Not seismic tested or approved.**

AP - AIRPORT SUPPORT SYSTEM

Specification:

Dimensions - 2" High x 5" Wide x Length (Base Length)

Material

Base - 100% recycled rubber, UV resistant

Maximum Load - 500 lbs.

Function: The AP Series is designed to provide support for all electrical and HVAC equipment. Grooved recessed tray prevents movement and dampens vibration. Allows water passage; prevents growth of moss and mold. Lightweight. Consult roofing manufacturer or engineer for roof loading.



Environmentally Friendly
made from 100% recycled tires

AP36 illustrated

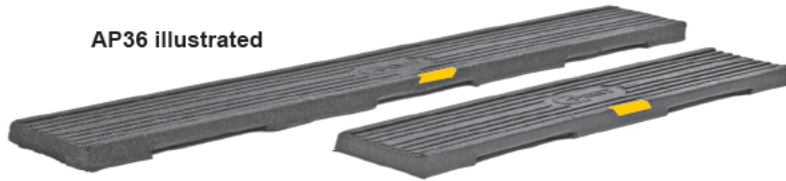

AP24 illustrated



Consult with roofing consultant for allowable loads



AP6 illustrated

MODEL #	HEIGHT (H)	WIDTH (W)	LENGTH (L)	WEIGHT	LIST PRICE
AP6	2" (51)	5" (127)	5 1/2" (140)	2.20 lbs.	\$10.50
AP24	2" (51)	5" (127)	24" (610)	7.12 lbs.	\$27.00
AP36	2" (51)	5" (127)	36" (914)	12.14 lbs.	\$35.00

CSE - COPPER TUBE AND STEEL PIPE SUPPORT

Specification:

Base – Recycled rubber, UV resistant

Dimensions: 6" wide x 4" high x 4 1/2" long

Pipe Clamp Material: Rubber lined clamps. Specify clamp size – 1/2", 3/4", 1", 1 1/4", 1 1/2" and 2" pipe clamp sizes available. Order by Suffix -50, -75, -100, -125, -150 or -200.

Threaded Rod / Hardware: Electro Plated Steel

Maximum Load – 150 Lbs.



Environmentally Friendly
made from 100% recycled tires



MODEL #	HEIGHT (H) (to top of base)	WIDTH (W)	LENGTH (L)	WEIGHT	LIST PRICE
CSE5-10	4" (102)	6" (152)	4 1/2" (114)	3.00 lbs.	\$19.50

CC - COPPER PIPING SUPPORT



Environmentally Friendly
made from 100% recycled
tires



Specification:

Base - Recycled rubber with 14 gauge Galvanized combination channel fitting. (Back to back 13/16" strut welded to galvanized steel plate.)

Dimensions: 4" High x 6" Wide x 9.6" Long

Material: 100% recycled rubber, UV resistant

Maximum Load - 350 lbs.

Function: The CC Series is designed for support of copper piping on any roofing material or other flat surfaces. The channel will accept strut clamps (by others) for adjustable heights.

U.S. Patent
 No. 7,866,093

MODEL #	HEIGHT (H)	WIDTH (W)	LENGTH (L)	WEIGHT	LIST PRICE
CC10-18	18" (457)	6" (152)	9.6" (244)	9.25 lbs.	\$86.00

CP - PLATFORM SERIES



Environmentally Friendly
made from 100% recycled
tires



Specification:

Dimensions

Base - 2" High x 5" Wide x 36" Length

Platform: 24" Wide x 36" - 72" Length

Material

Base - 100% recycled rubber, UV resistant

Platform: Galvanized steel

Maximum Load - 600 lbs.

Function: The CP Series is designed as a non-penetrating lightweight to bring to level platform surface. It is used for air conditioning, air condensing units, HVAC, and other electrical units. Free-flow leg system allows water passage. Other features include: prohibits moss and mold growth, easy to install, easy movement brackets that are suitable for all types of equipment, and adjustable. Consult roofing manufacturer or engineer for roof loading.

MODEL #	WIDTH (W)	LENGTH (L)	BASE LENGTH	QUANTITY	WEIGHT	LIST PRICE
CP36-2436	24" (610)	36" (914)	36" (914)	2	67.08 lbs.	\$647.00
CP36-2448	24" (610)	48" (1219)	36" (914)	2	70.92 lbs.	\$663.00
CP36-2472	24" (610)	72" (1829)	36" (914)	3	102.50 lbs.	\$951.00

C-PORT LOADING CHART (Lbs./inch²)

C Series	6" Wide Base with 1 5/8" x 1 5/8" Strut				
Base	C10	C20	C30	C40	C48
Total lbs./Base at 1 lb./in ²	30 lbs.	66 lbs.	87 lbs.	115 lbs.	144 lbs.

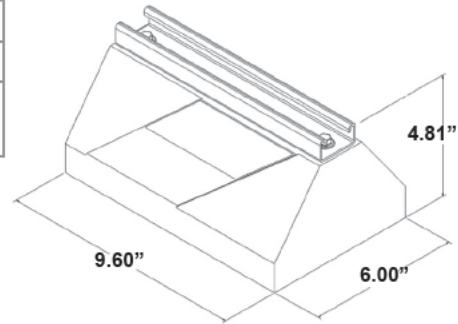

CW Series	12" Wide (Base) x (Length) with 1 5/8" x 1 5/8" Strut			
"L" Inches	12"	24"	36"	48"
Total lbs./Base at 1 lb./in ²	144 lbs.	288 lbs.	432 lbs.	576 lbs.

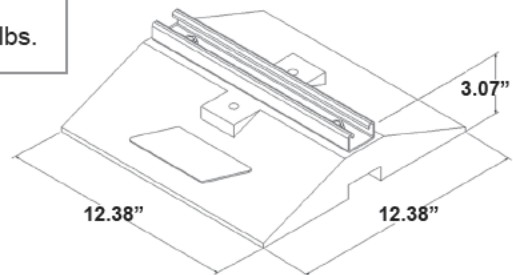

Consult with roofing consultant for allowable loads



REMEMBER TO CHECK WITH YOUR ROOF MANUFACTURER OR ENGINEER FOR ROOF LOADING AND MEMBRANE COMPATIBILITY

STEEL PIPE WEIGHT

Pipe Diameter (inches)	Gas Filled		Water Filled	
	Schedule 40 Weight lbs./Ft.	Schedule 80 Weight lbs./Ft.	Schedule 40 Weight lbs./Ft.	Schedule 80 Weight lbs./Ft.
1	1.68	2.17	2.06	2.48
1 1/4	2.27	3	2.92	3.56
1 1/2	2.72	3.63	3.6	4.4
2	3.68	5.02	5.1	6.3
2 1/2	5.79	7.66	7.87	9.49
3	7.58	10.25	10.78	13.12
3 1/2	9.11	12.51	13.4	16.23
4	10.79	14.98	16.32	19.95
5	14.62	20.78	23.28	28.65
6	18.98	28.57	31.49	39.86
8	25.55	43.4	47.15	63.2
10	40.5	64.74	74.6	95.84
12	53.6	88.6	102.1	132.6
14	63.37	107	121.87	158.2
16	85	137	159.5	206.7
18	103	171	202.2	259.5
20	123	209	243.4	318.4
24	171	297	345.2	455.2

CROSS REFERENCE

CX Series - Rubber Supports, Small Base (Page 1)			
C-PORT	Dura-Block (B-Line)	Miro	Erico
CXM	DBM	-	182365, 182370, 182375
CXP Series - Rubber Supports, Regular Base (Page 1)			
C-PORT	Dura-Block (B-Line)	Miro	Erico
CXP	DBP	RSS4	RPSE1H24, RPSE1H57, RPSE2H46
			RPS50H4EG, RP-S50H6EG, RPS50AHSV, PPRPS25H4
CXP-2	-	RSS4	-
CXW Series - Rubber Supports, Widebody Base (Page 3)			
C-PORT	Dura-Block (B-Line)	Miro	Erico
CXW12	-	M8-UFS	-
CXW24	-	-	-
CXW36	-	-	-
C Series - Rubber Supports with 7/8" High Galvanized Steel Channel (Page 2)			
C-PORT	Dura-Block (B-Line)	Miro	Erico
C5	DB5	1.5	-
C10	DB10	2.5-Conduit Support-2	RPS360400, 360400
C20	DB20	-	RPS360403, 360403
C30	DB30	-	-
C40	DB40	-	-
C48	DB48	-	-
C5 & C6 Series - Rubber Supports with 1 5/8" High Galvanized Steel Channel (Page 2)			
C-PORT	Dura-Block (B-Line)	Miro	Erico
C510	-	2.5-Conduit Support-5	PPRPS25H6
C610	DB610	2.5-Conduit Support-7	RPS360401, 360401
C620	DB620	-	RPS360404, 360404
C630	DB630	-	-
C640	DB640	-	-
CW - Widebody Base with 1 5/8" High x 13/16" Galvanized Steel Channel (Page 3)			
C-PORT	Dura-Block (B-Line)	Miro	Erico
CW12	-	-	RPS360403
CW24	-	-	RPS600T2
CW36	-	-	-
CW48	-	-	-
CW60	-	-	-
CW72	-	-	-

CGW - Widebody Base with 1 5/8" High x 13/16" Galvanized Steel Channel and Gasket (Page 4)			
C-PORT	Dura-Block (B-Line)	Miro	Erico
CGW12	-	-	-
CGW24	-	-	-
CGW36	-	-	-
CGW48	-	-	-
CE - Extension Series - Regular Base (Page 5)			
C-PORT	Dura-Block (B-Line)	Miro	Erico
CE10-8	DBE10-8	20-Base Strut-7, 2.5-Conduit Support-5 / 7	-
CE10-12	DBE10-12	2.5-Conduit Support-12	RPS360402, 360402
CEW - Extension Series - Widebody Base (Page 5)			
C-PORT	Dura-Block (B-Line)	Miro	Erico
CEW12-8	-	16-Base Strut-7, 16-Base-Strut-7-HDG-SS	-
CEW12-12	-	16-Base Strut-12	-
CEW12-16	DBE10-16	16-Base Strut-12	RPS360405, 360405
CRM - Roller Series, Small Base (Page 6)			
C-PORT	Dura-Block (B-Line)	Miro	Erico
CRM	-	3-R-2	-
CR - Roller Series, Regular Base (Page 6)			
C-PORT	Dura-Block (B-Line)	Miro	Erico
CR10-3	DBR2-31/2	6-RAH-7, 6-RAH-7-HDG-SS	RPS360406, 360406
CR10-4	DBR4-6	4-R	-
CRE - Extended Roller Series, Regular Base (Page 7)			
C-PORT	Dura-Block (B-Line)	Miro	Erico
CRE10-8-3	DBR10-12	3-RAH-7, 3-RAH-7-HDG-SS	RPS360407, 360407
CRE10-8-4	DBR10-12	4-RAH-7, 4-RAH-7-HDG-SS	-
CRE10-12-3	DBR10-12	3-RAH-12	-
CREW - Extended Roller Series, Widebody Base (Page 7)			
C-PORT	Dura-Block (B-Line)	Miro	Erico
CREW12-12-3	-	-	-
CREW12-12-4	-	-	-
CREW12-12-6	-	6-RAH-12	360409
CREW12-16-3	-	5-RAH-7	-
CREW12-16-4	-	5-RAH-12	-
CREW12-16-6	-	-	RPS360409

CROSS REFERENCE

CB - Bridge Support w/ two CX Supports & 1 5/8" High Galvanized Steel Channel (Page 8)

C-PORT	Dura-Block (B-Line)	Miro	Erico
CB10-28	DB10-28	-	-
CB10-36	DB10-36	-	-
CB10-42	DB10-42	-	-
CB10-50	DB10-50	-	-
CB10-60	DB10-60	-	-

CES - Bridge Support w/ two Medium Load Supports & 1 5/8" High Galv. Steel Channel (Page 8)

C-PORT	Dura-Block (B-Line)	Miro	Erico
CES10-1012	-	-	-
CES10-1024	-	-	-

CESW - Medium Load, Water and Steam Supports, 1 5/8" High Galvanized Steel Channel (Page 10)

C-PORT	Dura-Block (B-Line)	Miro	Erico
CESW12-2424	-	2.5-SB-H	-
CESW12-3624	-	5-SB-H, 8-SB-H, 8-SB-HD, 5-SB-H-HDG	-
CESW12-4824	-	-	-

CESHW - Heavy Load Series w/ two Widebody Supports, 1 5/8" High Galvanized Steel Channel (Page 9)

C-PORT	Dura-Block (B-Line)	Miro	Erico
CESHW12-1624	-	-	-
CESHW12-1636	-	-	-

DSA10 - Duct Support Series, Regular Base (Page 12)

C-PORT	Dura-Block (B-Line)	Miro	Erico
DSA10-1831	-	4-DSA-12, 4-DSA-18	-
DSA10-3157	-	-	-
DSA10-57102	-	-	-

CC - Copper Piping Support (Page 15)

C-PORT	Dura-Block (B-Line)	Miro	Erico
CC10-18	-	-	RPS360422, RPS360423, 360422, 360423

DSAW - Duct Support Series, Widebody Base (Page 12)

C-PORT	Dura-Block (B-Line)	Miro	Erico
DSAW-1831	DB-DS Series	6-DSA, 6-DS, 6-DS-HDG-SS	RPS360420, RPS360421, 360420, 360421
DSAW-3157	DB-DS Series	8-DSA	-
DSAW-57102	DB-DS Series	8-DS-SB, 8-DS-HDG-SS	-

CS - 1 5/8" Steel Channel Series w/ 6" Adjustable, 1 7/8" x 1 7/8" Square Leg (Page 13)

C-PORT	Dura-Block (B-Line)	Miro	Erico
CS10	-	-	-
CS20	-	-	-
CS30	-	-	-
CS40	-	-	-
CS48	-	-	-

CZ - Seismic Series (Page 13)

C-PORT	Dura-Block (B-Line)	Miro	Erico
CZ10	-	-	-
CZ20	-	-	-
CZ30	-	-	-
CZ40	-	-	-

AP - Airport Support System (Page 14)

C-PORT	Dura-Block (B-Line)	Miro	Erico
AP6	-	-	-
AP24	-	-	RPS150T1
AP36	-	-	-

CP - Platform Series (Page 15)

C-PORT	Dura-Block (B-Line)	Miro	Erico
CP36-2436	-	-	-
CP36-2448	-	-	-
CP36-2472	-	-	-

CSE - Copper Tube and Steel Tube Pipe Support (Page 14)

C-PORT	Dura-Block (B-Line)	Miro	Erico
CSE5-10	DBM -1, DBM-2CT	-	-

CESWX - Double Widebody, Water and Steam Support, Heavy Duty (Page 11)

C-PORT	Dura-Block (B-Line)	Miro	Erico
CESWX24-2424	-	8-H-DB, 8-H-SB, 8-H-HDG-SS	-
CESWX24-3624	-	8-H-DB, 8-H-SB, 8-H-HDG-SS	-
CESWX24-4824	-	8-H-DB, 8-H-SB, 8-H-HDG-SS	-

CESWXX - Quadruple Widebody, Water and Steam Support, Extra Heavy Duty (Page 11)

C-PORT	Dura-Block (B-Line)	Miro	Erico
CESWXX24-2424	-	10-H, 16-H, 16-H-HDG	-
CESWXX24-3624	-	10-H, 16-H, 16-H-HDG	-
CESWXX24-4824	-	10-H, 16-H, 16-H-HDG	-

PIPE CLAMPS

Strut Clamp (for C-PORT models C5, C10 to C48, C510 to C640, CGW, CE, CEW, CB, CES CESHW, CW and CZ Series)
 (Standard finish is zinc electroplate). When ordering, refer to outside dimension of the selected pipe to ensure the correct OD clamp is ordered to match the OD of the pipe.

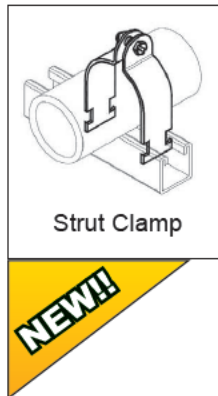

Model #	Pipe Size	List Price, each	Box Qty
CLAMP.50	1/2"	\$1.75	100
CLAMP.75	3/4"	\$1.85	100
CLAMP1.00	1"	\$1.95	100
CLAMP1.25	1 1/4"	\$2.00	50
CLAMP1.50	1 1/2"	\$2.25	50
CLAMP2.00	2"	\$2.50	50
CLAMP2.50	2 1/2"	\$3.00	50
CLAMP3.00	3"	\$3.50	25
CLAMP3.50	3 1/2"	\$4.00	25
CLAMP4.00	4"	\$4.50	25
CLAMP5.00	5"	\$5.00	25
CLAMP6.00	6"	\$6.50	25

Single Piece Pipe Strap (for C-PORT models CXM, CXP, CXP-2 and CXW Series)
 (Standard finish is zinc electroplate)



Model #	Pipe Size	List Price, each	Box Qty
STRAP.50	1/2"	\$4.00	25
STRAP.75	3/4"	\$4.00	25
STRAP1.00	1"	\$4.50	25
STRAP1.25	1 1/4"	\$5.00	25
STRAP1.50	1 1/2"	\$5.50	25
STRAP2.00	2"	\$11.00	25
STRAP2.50	2 1/2"	\$11.50	25
STRAP3.00	3"	\$13.00	25
STRAP3.50	3 1/2"	\$13.50	10
STRAP4.00	4"	\$14.50	10
STRAP5.00	5"	\$19.50	bulk
STRAP6.00	6"	\$25.00	bulk



**FOR THOSE JOBS
WHEN YOU NEED TO
PUT AN ESCALADE
ON THE ROOF?**

MIFAB®
C-PORT®
ROOFTOP SUPPORT SOLUTIONS
www.c-port.net

**CAN C-PORT HANDLE HEAVY
LOADS? YES.**

**2005 CADILLAC ESCALADE
CURB WEIGHT: 5,800 LBS**

BUT WHY WOULD YOU??

CE-EXTENSION SERIES

-2 Electro-Zinc All Threaded Rod Risers
 (14ga. Galvanized Channel 7/8" high)

Roof *Safe* Maximum Load: 400lbs.
**Ask what the roof can take,
 not the support!**

Order the "Cadillac" of Pipe Supports Today!



TERMS AND WARRANTIES

WHOLESALE DISCOUNT: Contact MIFAB[®] or your local representative for your applicable discount structure.

FREIGHT ALLOWANCE: Ex Works, MIFAB's Chicago, Illinois Factory or Manufacturer Representative's warehouse with full motor freight allowed on shipments of \$1,500.00 Net or more, within the continental U.S.A. or Canada, except Alaska, Hawaii and Puerto Rico. MIFAB[®] reserves the right to choose the carrier and route of shipment. Alaska: Ex Works, Seattle, WA. Hawaii: Freight allowed on shipments of \$1,500.00 or more only when shipped from West Coast, U.S. Puerto Rico: Ex Works, Miami, Florida. There is no allowance for United Parcel Service, Federal Express or Shipment by air service. Full motor freight is allowed on shipments of \$1,500.00 Net or more, within the continental U.S.A. and Canada for any combination of BEECO, Counterline, No Hub Coupling, Trench Drain, Access Door and Trap Seal Primer products. Shipping dates are estimates and time of delivery is not the essence of the sale of the contract. Therefore, under no circumstances will MIFAB have any responsibility on account of any delays in manufacture, transportation, or otherwise. Additional freight services such as construction site delivery, lift gate delivery service, re-consigned freight or notification charges, are not included in full freight allowance terms, and will result in additional freight charges.

QUOTATION TERMS: List Price and discount protected for 30 days from date issued by MIFAB[®]. Orders received within this period must be released for shipment within 30 days from date of purchase order, otherwise, prices will be those that are in effect at the time of shipment.

PAYMENT TERMS: Terms of payment are Net 30 days from the date of the invoice. All pricing in United States currency unless sold in Canada in which case Canadian dollars is the currency used. The Buyer shall pay all sales, consumers, and / or any other applicable taxes. Past due accounts will be subject to a 2% per month service charge from the date of the invoice. If any proceedings be instructed by or against Buyer under any bankruptcy or insolvency law, or if Buyer shall fail to make timely payment on this or any other order, or if, in MIFAB's judgment, Buyer's financial situation justifies such action, MIFAB[®] may, at its election, require payment in advance or cancel the order as to any unshipped item and require payment of its reasonable cancellation charges. If Buyer delays completion of manufacture, MIFAB[®] may elect to require payment according to percentage of completion. Equipment held for Buyer shall be at Buyer's risk and expense. In all cases, regardless of partial payment, title to the Products shall remain with MIFAB[®] until payment for the Products (including any notes given therefore) has been made in full. Should legal action be necessary to enforce payment of an unpaid invoice, the Buyer will assume full responsibility for any court costs and reasonable attorney fees. All orders subject to credit check and approval prior to shipment. Confirmed irrevocable letter of credit or cash in advance of shipment is required for accounts without an established line of credit. Minimum invoice amount is \$100.00. MIFAB reserves the right to apply a minimum order charge to equal \$100.00. MIFAB's Accounting Department must be notified of potential pricing errors within 30 days of the invoice date. Any terms and conditions stated on Buyer's orders which are inconsistent with MIFAB's quotation and Terms and Warranties shall be of no effect.

RETURNED GOODS RESTOCKING CHARGE: Standard product may be returned within a one year period only with written permission from MIFAB[®]. All products in catalog are not considered Standard. Standard product to be determined by MIFAB[®]. Returned goods are subject to a 25% restocking charge, plus cost of reconditioning, if necessary, to make material saleable. Material must be returned to MIFAB[®] freight prepaid only after written permission from MIFAB[®] to accept the returned material. Buyer must provide copy of the original invoice on which the material was charged. The original outgoing freight cost to ship the order will be deducted from the credit. Credit allowance will be in the form of merchandise credit only-not cash credit which must be used within 12 months of the date of issue. The value of a return must total \$100.00 to qualify for credit allowance. Galvanized and acid resistant epoxy coated material will be credited to value of cast iron, and chrome plated at value of nickel bronze. No credit will be allowed for auxiliary tappings, discontinued, or made to order items. Products designated non stock and / or that have been specially made (require a sign off drawing by MIFAB[®]) are not subject to return or cancellation.

LIMITED WARRANTY: MIFAB[®] warrants each product against defects in material and workmanship for a period of one year from the date of original shipment. In the event of such defects within the warranty period, MIFAB[®] will, at its option, replace or recondition the product without charge. This shall constitute the exclusive remedy for breach of warranty, and MIFAB[®] shall not be responsible for any incidental or consequential damages, including, without limitation, damages or other costs resulting from labor charges, delays, vandalism, negligence, fouling caused by foreign material, damage from adverse water conditions, chemicals, or any other circumstances over which MIFAB[®] has no control. This warranty shall be invalidated by any abuse, misuse, misapplication or improper installation of the product.

MIFAB MAKES NO OTHER WARRANTIES EXPRESSED OR IMPLIED AS PROVIDED IN THIS LIMITED WARRANTY.

ILLUSTRATIONS OR TYPICAL INSTALLATIONS: The typical installations for various products in each product section are intended to illustrate the products and their options. Under no circumstances are they to be construed as recommended installation procedures. Consult local codes and project specifications for proper installation instructions.

ALL SALES SUBJECT TO MIFAB's TERMS AND WARRANTIES.

NOTE: Prices and terms are subject to change without notice and supersede all previous quotations. The right is reserved to change or modify product design or construction without prior notice and without incurring any obligation to make similar changes and modifications to product previously or subsequently sold. Contact MIFAB[®] for any clarification.

CONTENTS © MIFAB[®] INC. Copyright 2014



Air Conditioning Support

Contributes
to LEED credit*

*In the material and resources category



MADE FROM 100%
RECYCLED TIRES



Cable Tray Support

Extends Roof Life

Dampens Vibrations

Curb Replacement

The recycled tire composition of C-Port is economical, environmentally safe and will not deteriorate in time.

C-Port can be used on any roof membrane; shingles, modified, metal, single-ply or built up, with no additional padding required.



Duct Support

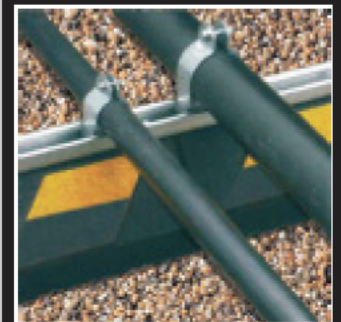

Gas Pipe Support



Platform Support



Extended Height Pipe Support

LIT-047

Adaptable to any Roof Pitch.

**YOUR ROOFTOP
SUPPORT SOLUTION**